

PART NUMBER CONSTRUCTION CHART							
ASSEMBLY LENGTHS	L1	L2	L3	L4	L5	L6	L7
	6"	12"	18"	24"	36"	48"	96"
<b>CUSTOM LENGTHS:</b> CONTACT FACTORY							

**TO CONSTRUCT A PART NUMBER, MATCH THE LENGTH "L" WITH AN ASSEMBLY NUMBER**

**EXAMPLE:** If you require assembly part # **14106-** and you want it to be **36"** long, then your part # would be **14106-L5**

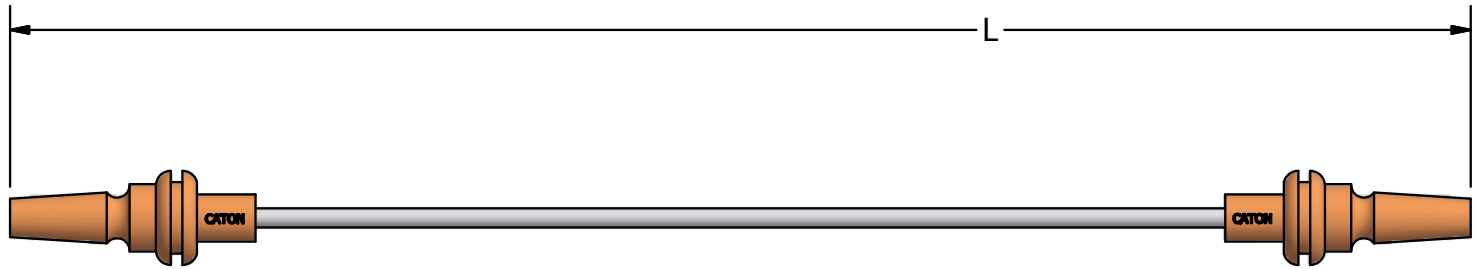

ASSEMBLY PART #14106-



ASSEMBLY PART #14107-



ASSEMBLY PART #14105-

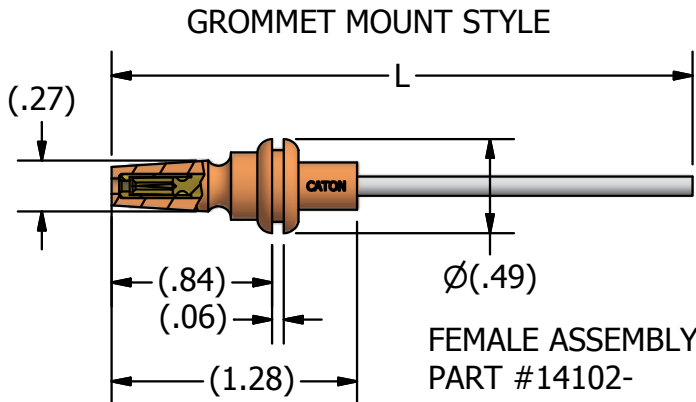

FEMALE ASSEMBLY PART #14102-

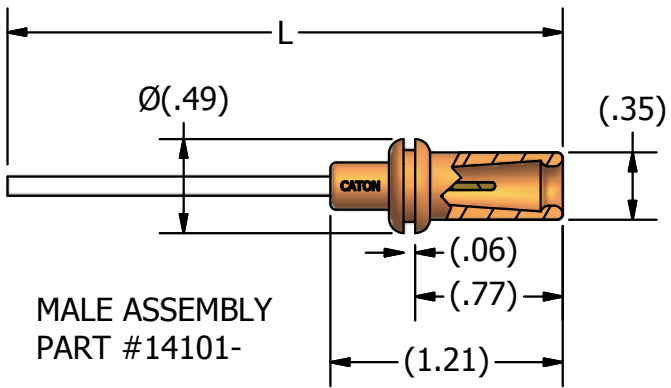

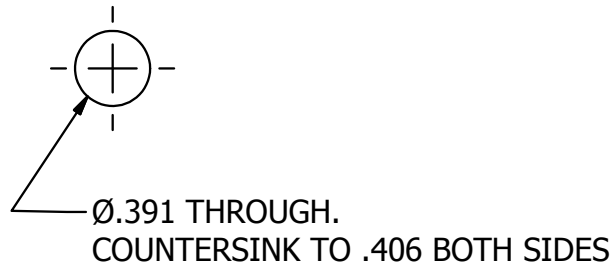

MALE ASSEMBLY PART #14101-

**MOUNTING HOLE DIMENSIONS**

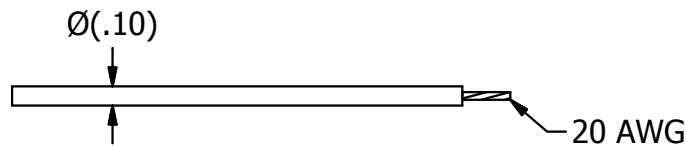

**14 SERIES 10 KVDC WIRE, PART # CC20100**





*...assuring mission success since 1973*

SERIES	VOLTAGE	CURRENT
14	10 KVDC	4 AMPS
<b>WEB</b> WWW.CATON.COM	<b>PHONE</b> 781-585-4315	<b>FAX</b> 781-585-2973

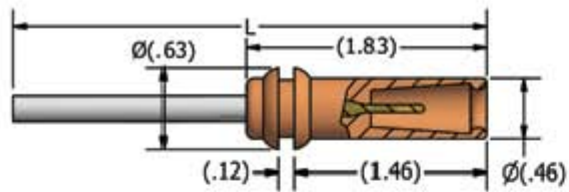

MALE GROMMET MOUNT STYLE  
ASSEMBLY PART # 14201-

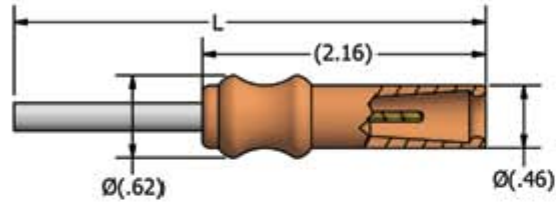

MALE FINGER GRIP STYLE  
ASSEMBLY PART # 14203-



ASSEMBLY PART # 14205-



ASSEMBLY PART # 14208-



ASSEMBLY PART # 14207-



ASSEMBLY PART # 14210-



ASSEMBLY PART # 14206-



ASSEMBLY PART # 14209-

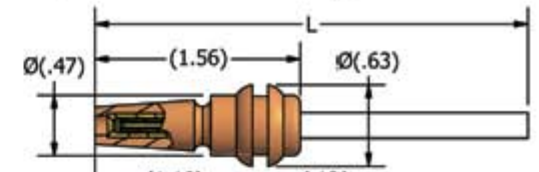

FEMALE GROMMET MOUNT STYLE  
ASSEMBLY PART # 14202-

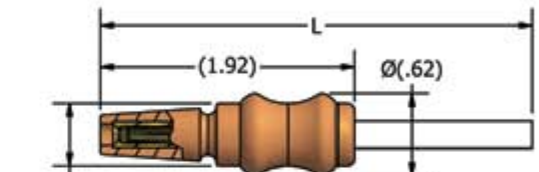

FEMALE FINGER GRIP STYLE  
ASSEMBLY PART # 14204-

**PART NUMBER CONSTRUCTION CHART**

ASSEMBLY LENGTHS	L1	L2	L3	L4	L5	L6	L7
	6"	12"	18"	24"	36"	48"	96"

**CUSTOM LENGTHS:** CONTACT FACTORY

**TO CONSTRUCT A PART NUMBER,  
MATCH THE LENGTH "L" WITH AN  
ASSEMBLY NUMBER**

**EXAMPLE:** If you require assembly part # **14206-** and you want it to be **36"** long, then your part # would be **14206-L5**

**MOUNTING HOLE DIMENSIONS**



**14 SERIES 30 KVDC WIRE**

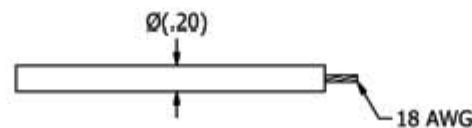



...assuring mission success since 1973

SERIES	VOLTAGE	CURRENT
14	30 KVDC	7.5 AMPS
WEB WWW.CATON.COM	PHONE 781-585-4315	FAX 781-585-2973

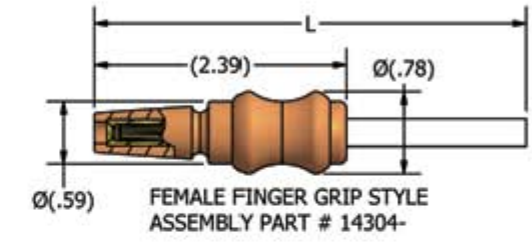
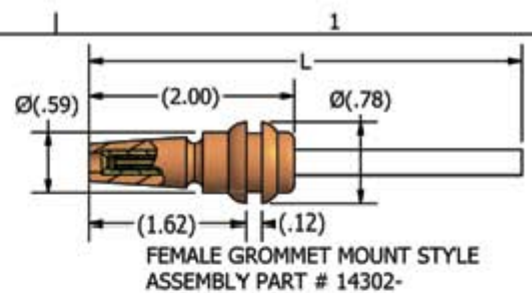
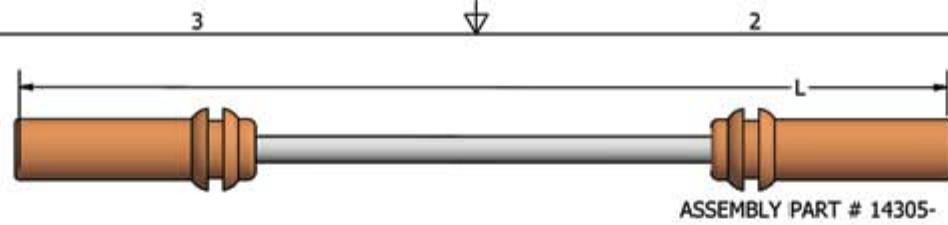
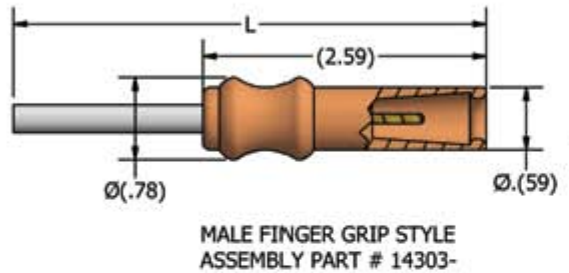
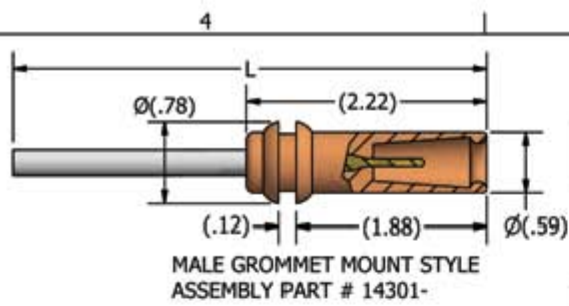

PART NUMBER CONSTRUCTION CHART							
ASSEMBLY LENGTHS	L1	L2	L3	L4	L5	L6	L7
		6"	12"	18"	24"	36"	48"
CUSTOM LENGTHS: CONTACT FACTORY							
TO CONSTRUCT A PART NUMBER, MATCH THE LENGTH "L" WITH AN ASSEMBLY NUMBER							
EXAMPLE: If you require assembly part # 14206- and you want it to be 36" long, then your part # would be 14306-L5							

MOUNTING HOLE DIMENSIONS



14 SERIES 45 KVDC WIRE, PART # CC45295



SERIES	VOLTAGE	CURRENT
14	45 KVDC	10 AMPS
WEB WWW.CATON.COM	PHONE 781-585-4315	FAX 781-585-2973